

BANDEJAS PERFORADAS

TAPA ESLABÓN

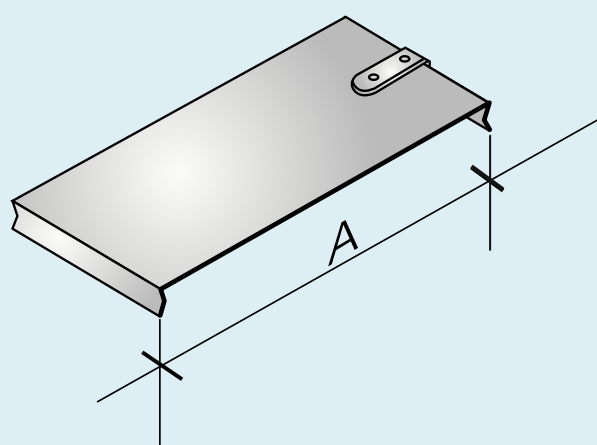

A mm.	CÓDIGO	
	Espesor	
	0,7 mm.	0,9 mm.
50	TEP-07-050	-
100	TEP-07-100	-
150	TEP-07-150	-
200	TEP-07-200	-
250	TEP-07-250	-
300	TEP-07-300	-
450	-	TEP-09-450
600	-	TEP-09-600