

BANDEJAS PERFORADAS

FONDO SÓLIDO ALA 50 mm.

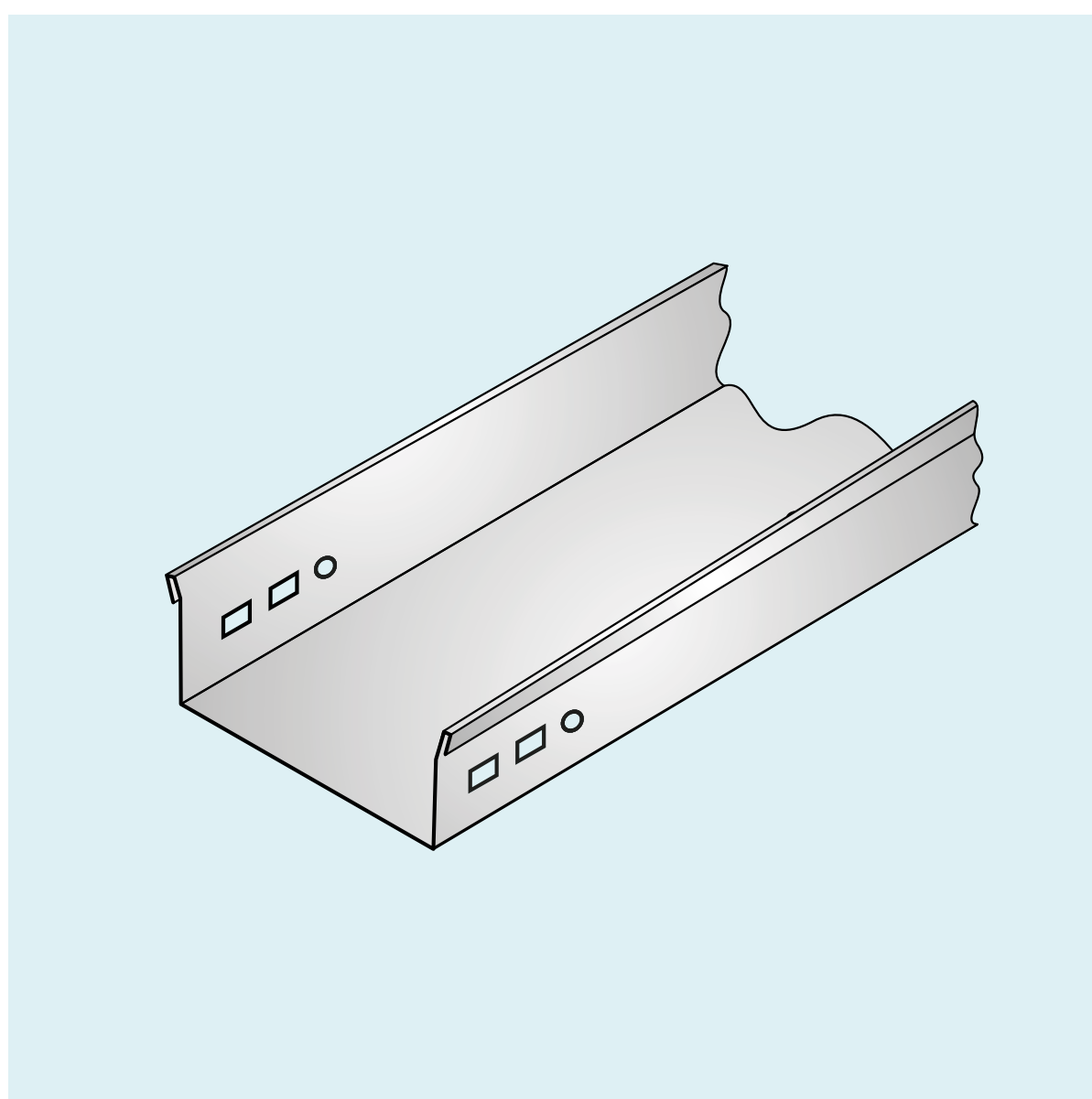

1,6 mm.	CÓDIGO			
	Espesor de chapa			
	0,7 mm.	0,9 mm.	1,2 mm.	1,6 mm.
50	BS50-07-050	BS50-09-050	BS50-12-050	BS50-16-050
100	BS50-07-100	BS50-09-100	BS50-12-100	BS50-16-100
150	BS50-07-150	BS50-09-150	BS50-12-150	BS50-16-150
200	BS50-07-200	BS50-09-200	BS50-12-200	BS50-16-200
250	BS50-07-250	BS50-09-250	BS50-12-250	BS50-16-250
300	BS50-07-300	BS50-09-300	BS50-12-300	BS50-16-300
450	BS50-07-450	BS50-09-450	BS50-12-450	BS50-16-450
600	BS50-07-600	BS50-09-600	BS50-12-600	BS50-16-600