

PERFILES C

PERFIL C 44x44
TRAMO 6000 mm.

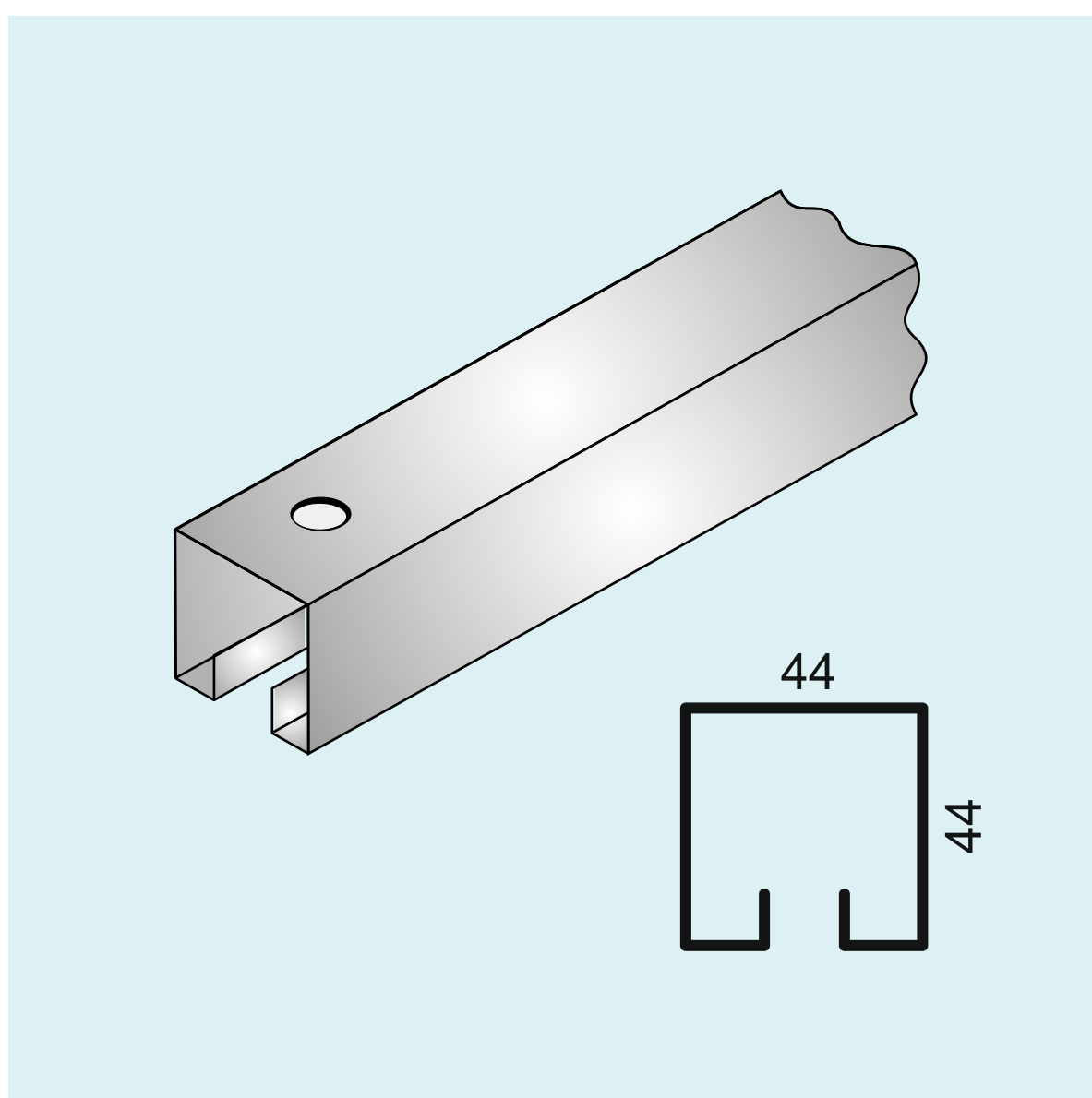

CÓDIGO		
0,9 mm.	1,2 mm.	2,0 mm.
PC44.44-09-6000	PC44.44-12-6000	PC44.44-20-6000