

PERFILES C

PERFIL C 44x28
TRAMO 1220 mm.

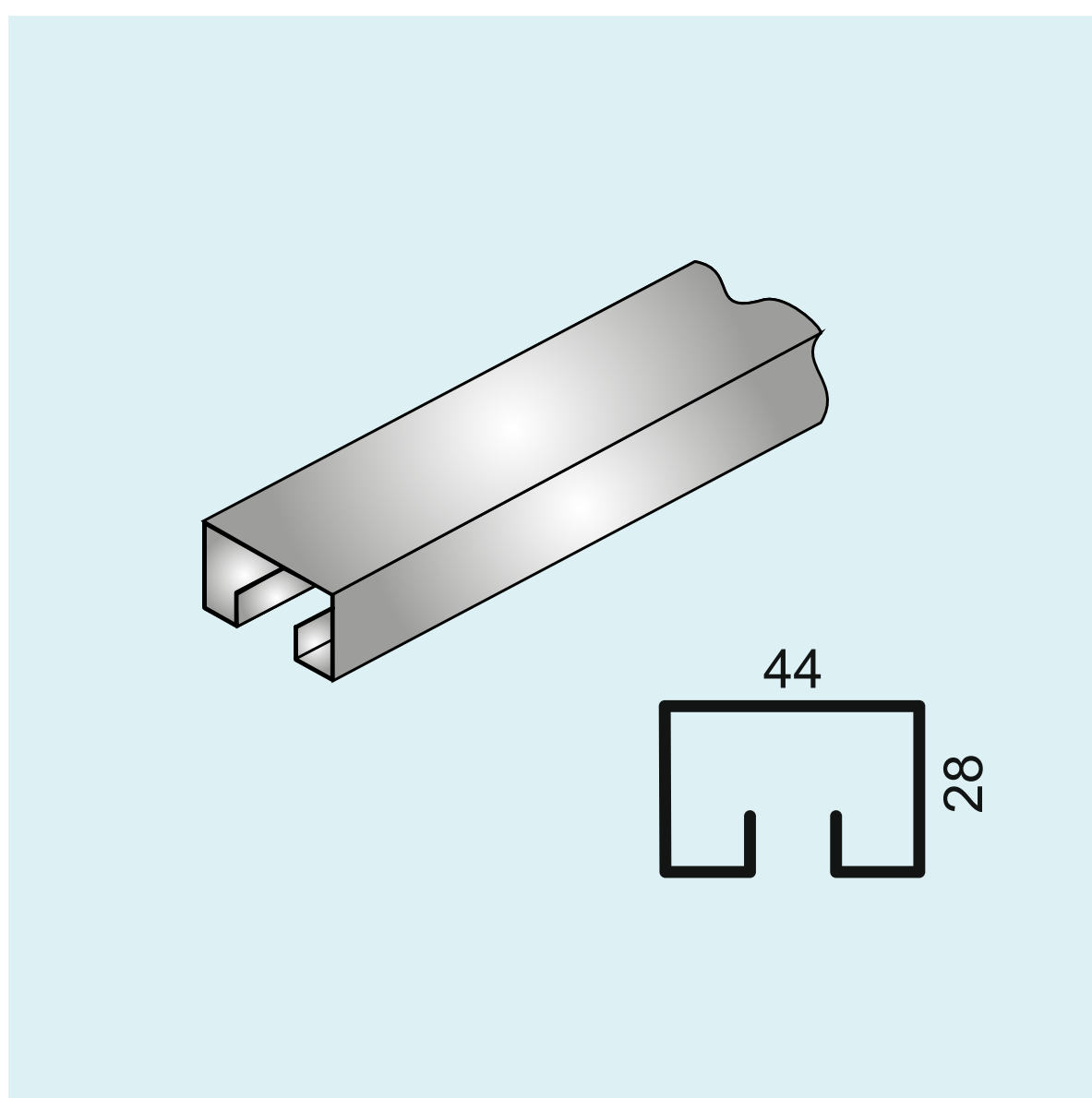

CÓDIGO		
0,9 mm.	1,2 mm.	1,6 mm.
PC44.28-09-1220	PC44.28-12-1220	PC44.28-16-1220